

Reactivity 1.3

Answers

IB CHEMISTRY SL

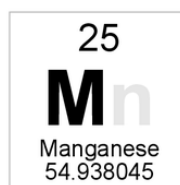
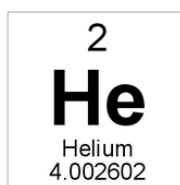
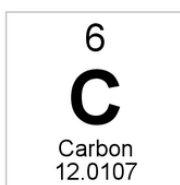
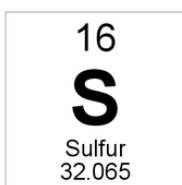
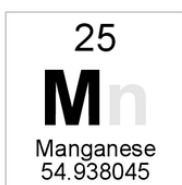

Reactivity 1.3.1 and 1.3.2

Understandings:

- Reactive metals, non-metals and organic compounds undergo combustion reactions when heated in oxygen (1.3.1).
- Incomplete combustion of organic compounds, especially hydrocarbons, leads to the production of carbon monoxide and carbon (1.3.2).

Learning outcomes:

- Deduce equations for reactions of combustion, including hydrocarbons and alcohols (1.3.1).
- Deduce equations for the incomplete combustion of hydrocarbons and alcohols (1.3.2).

Linking questions:

- Reactivity 2.2 Why is high activation energy often considered to be a useful property of a fuel?
- Reactivity 3.2 Which species are the oxidizing and reducing agents in a combustion reaction?
- Reactivity 2.1 How does limiting the supply of oxygen in combustion affect the products and increase health risks?

Combustion reactions

- Alkanes, alcohols and reactive metals undergo combustion reactions with oxygen.
- In a combustion reaction, a substance reacts with oxygen (usually from the air) releasing energy in the form of heat and light.
- Combustion can be complete or incomplete depending how much oxygen is available.
- Complete combustion occurs when a substance is burned in excess oxygen.
- Incomplete combustion occurs when a substance is burned in insufficient oxygen.
- Incomplete combustion produces less energy per unit mass than complete combustion.

Combustion reactions of alkanes

- Alkanes are hydrocarbons which are compounds that consist of carbon and hydrogen only.
- Alkanes can undergo either complete or incomplete combustion, depending on the availability of oxygen.
- The complete combustion of propane, C₃H₈, produces carbon dioxide and water.

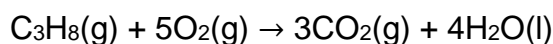

- The incomplete combustion of propane produces carbon monoxide (CO) and water or carbon and water.

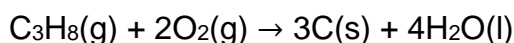
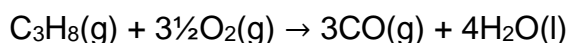

Combustion reactions of alcohols

- Alcohols are organic compounds composed of carbon, hydrogen and oxygen.
- Like alkanes they can also undergo complete or incomplete combustion.
- The complete combustion of ethanol, C₂H₅OH, produces carbon dioxide and water.

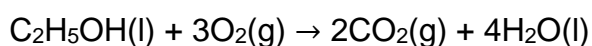

- The incomplete combustion of ethanol produces carbon monoxide and water or carbon and water.

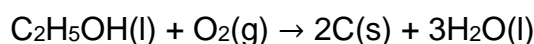
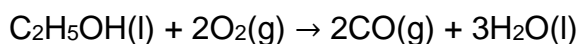

Reaction of reactive metals and non-metals

- Reactive metals such as magnesium react with oxygen to form metal oxides.

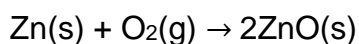
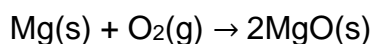

- Non-metals such as carbon react with oxygen to form non-metal oxides.

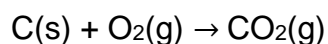

Exercises:

- 1) Outline the difference between complete and incomplete combustion.

Complete combustion occurs when there is an excess of oxygen. Incomplete combustion occurs when there is a limited supply of oxygen. The products of complete combustion are carbon dioxide and water. The products of incomplete combustion are carbon monoxide or carbon and water.

- 2) Write equations for the following reactions.

- (a) The complete combustion of butane, C_4H_{10}

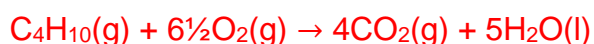

or

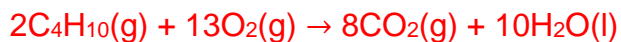

- (b) The incomplete combustion of butane, C_4H_{10}

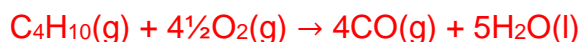

or

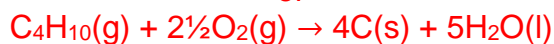

- (c) The complete combustion of methanol, CH_3OH

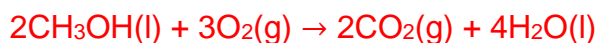

- (d) The incomplete combustion of methanol, CH_3OH

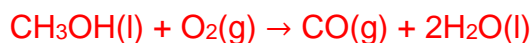

- (e) The reaction between zinc, Zn, and oxygen.



- (f) The reaction between sulfur, S, and oxygen.

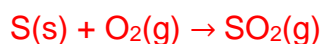

Reactivity 1.3.3

Understandings:

- Fossil fuels include coal, crude oil and natural gas, which have different advantages and disadvantages.

Learning outcomes:

- Evaluate the amount of carbon dioxide added to the atmosphere when different fuels burn.
- Understand the link between carbon dioxide levels and the greenhouse effect.

Additional notes:

- The tendency for incomplete combustion and energy released per unit mass should be covered.

Linking questions:

- Structure 3.2 Why do larger hydrocarbons have a greater tendency to undergo incomplete combustion?
- Structure 3.2 (HL) Why is carbon dioxide described as a greenhouse gas?

Fossil fuels

- Coal, oil and natural gas are fossil fuels.
- Fossil fuels were formed by the reduction of biological compounds that contain carbon, hydrogen, nitrogen, sulfur and oxygen.
- They were formed over millions of years, from the remains of dead organisms in anaerobic conditions (without oxygen).
- Coal was formed from dead plant material.
- Oil and natural gas were formed from dead marine organisms.
- Oil (crude oil / petroleum) is a complex mixture of straight-chain, branched, cyclic, and aromatic hydrocarbons.
- Natural gas is composed mainly of methane, with varying amounts of ethane, propane, and butane as well as hydrogen sulfide.
- Fossil fuels release large amounts of energy in exothermic combustion reactions.
- They also produce large amounts of carbon dioxide, CO₂, which is a greenhouse gas.
- Greenhouse gases contribute to the enhanced greenhouse effect.

Advantages and disadvantages of fossil fuels

Coal

Advantages	Disadvantages
Coal is relatively inexpensive	Coal is finite (non-renewable)
Coal has a high specific energy and high energy density	When burned, coal produces CO ₂ which is a greenhouse gas
Coal can be converted into liquid fuels (coal liquefaction) and gaseous fuels (coal gasification)	When burned, coal produces SO ₂ which causes acid deposition
Coal is distributed throughout the world	The mining of coal can cause environmental damage

Crude oil / petroleum products

Advantages	Disadvantages
Petroleum products are relatively inexpensive	Crude oil is finite (non-renewable)
Petroleum products generally have high specific energies and energy densities	When burned, petroleum products produce CO ₂ which is a greenhouse gas
Ease of transport (gasoline)	Drilling for and transporting crude oil can cause environmental damage
Can be used as feedstocks for petrochemicals	Uneven distribution worldwide

Natural gas

Advantages	Disadvantages
Natural gas is a relatively clean fuel	Natural gas is finite (non-renewable)
Natural gas has a higher specific energy than coal and oil	When burned, natural gas produces CO ₂ which is a greenhouse gas
Ease of transport in pressurized containers	Lower energy density than coal and oil
Does not contribute to acid deposition	Uneven distribution in the world

Evidence for global warming

- The graphs below show the concentration of CO₂ in the atmosphere since 1960 and the change in global temperature since 1860.

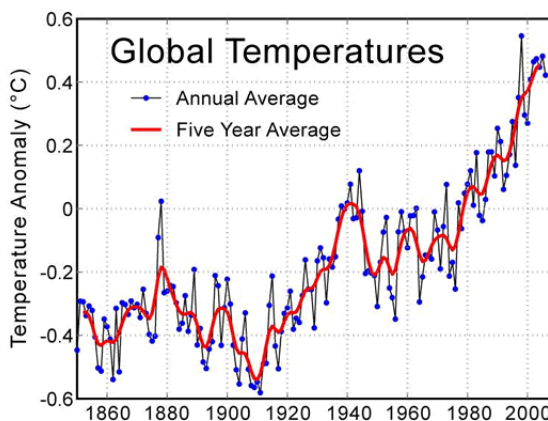
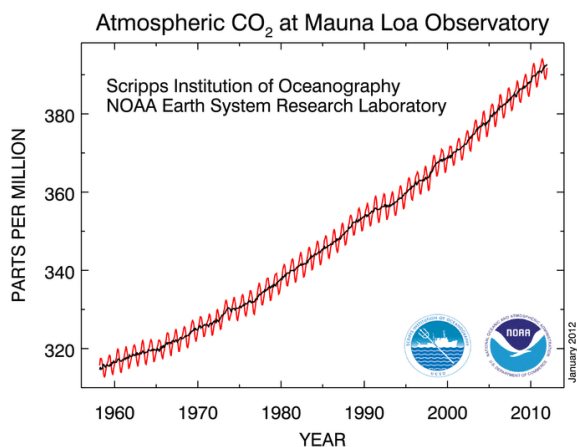

- Increasing CO₂ levels and the Earth's average temperature show a clear correlation, but wide variations in the surface temperature of the Earth have occurred frequently in the past.

Reactivity 1.3.4

Understandings:

- Biofuels are produced from the biological fixation of carbon over a short period of time through photosynthesis.

Learning outcomes:

- Understand the difference between renewable and non-renewable energy sources.
Consider the advantages and disadvantages of biofuels.

Additional notes:

- The reactants and products of photosynthesis should be known.

Renewable and non-renewable energy sources

- Renewable energy sources are naturally replenished.
- Non-renewable energy sources are finite.

Non-renewable sources	Renewable sources
Coal	Solar
Oil	Wind
Natural gas	Hydroelectric
	Geothermal
	Tidal
	Biomass

Biofuels

- Biofuels are a renewable energy source produced from biomass that gain their energy from biological carbon fixation.
- Carbon fixation is a process that takes inorganic carbon in the form of CO₂ and converts it into organic compounds such as glucose.
- Carbon fixation occurs during photosynthesis in which carbon dioxide and water react to produce glucose and water.

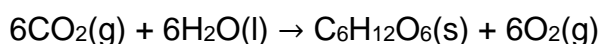

- The glucose produced in photosynthesis can be fermented to produce ethanol.

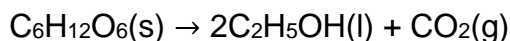

- The ethanol produced in fermentation can be mixed with gasoline (petrol) to produce ethanol fuel mixtures such as E10 (a mixture of 10% ethanol and 90% gasoline).

Advantages and disadvantages of biofuels

Advantages	Disadvantages
Biofuels are renewable and readily available.	The production of crops for biofuels means less land is available for food crops.
If the crops are regrown, biofuels can be sustainable.	Biofuels have lower specific energy than fossil fuels.
	Growing and harvesting crops for biofuels produces large amounts of CO ₂

Reactivity 1.3.5

Understandings:

- A fuel cell can be used to convert chemical energy from a fuel directly to electrical energy.

Learning outcomes:

- Deduce half-equations for the electrode reactions in a fuel cell.

Additional notes:

- Hydrogen and methanol should be covered as fuels for fuel cells.
- The use of proton exchange membranes will not be assessed.

Linking questions:

- Reactivity 3.2 What are the main differences between a fuel cell and a primary (voltaic) cell?

Fuel cells

- A fuel cell converts the chemical potential energy stored in a fuel into electrical energy.
- Two types of fuel cells are the hydrogen fuel cell and the direct methanol fuel cell (DMFC).

Hydrogen fuel cell

- In a hydrogen fuel cell, the fuel is hydrogen (H_2) and the product is water.

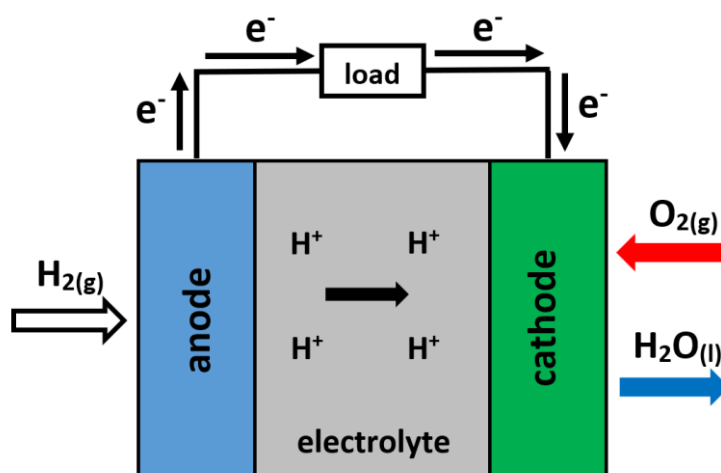

- At the anode, hydrogen is oxidised.

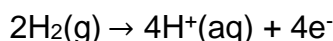

- At the cathode, oxygen is reduced.

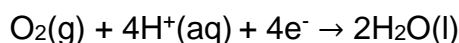

- Overall equation:

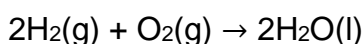

Direct methanol fuel cell (DMFC)

- In a direct methanol fuel cell, the fuel is a solution of methanol and water and the products are water and carbon dioxide.

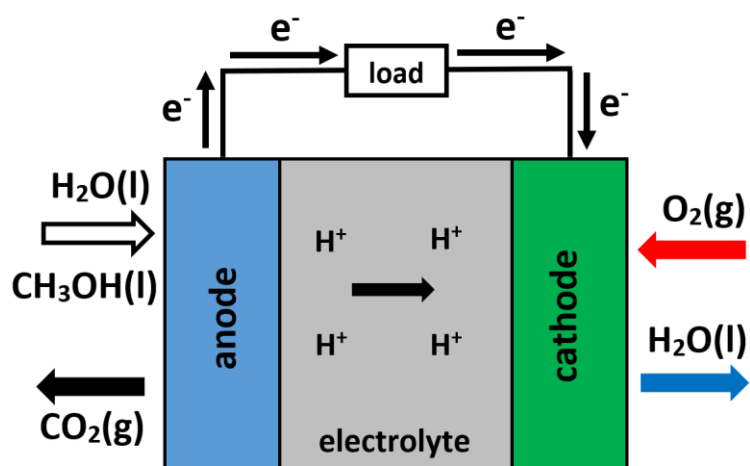

- At the anode, methanol is oxidised.

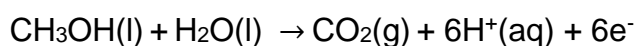

- At the cathode, hydrogen ions are reduced.

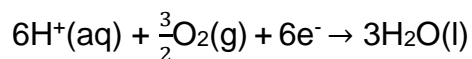

- Overall equation:

